

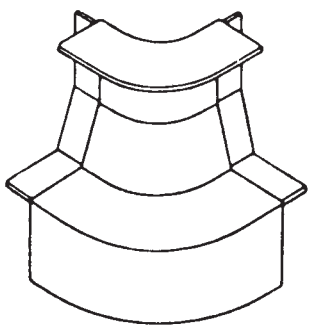

CR72
0.672 kg/ft
2.206 kg/m



Corner Casting CS103



CR18
0.576 kg.ft
1.891 kg/m

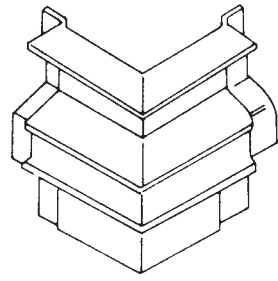

Corner Casting square CS12
radius CS12A

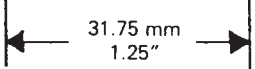

Cant Rails

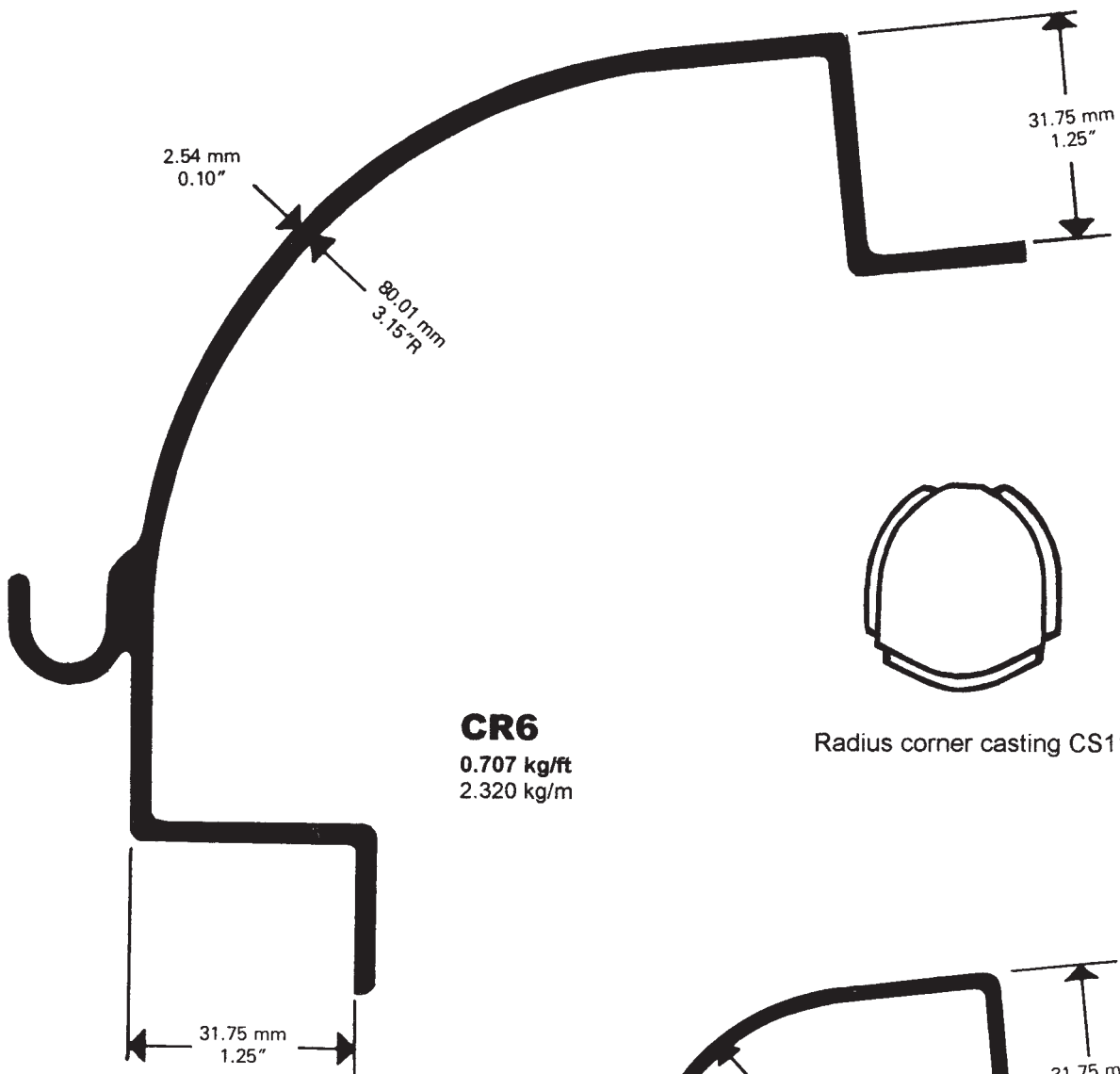

CR6
0.707 kg/ft
2.320 kg/m

Radius corner casting CS11

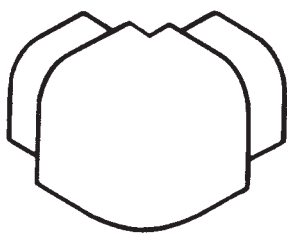

Corner Casting CS2
Corner Casting CS3

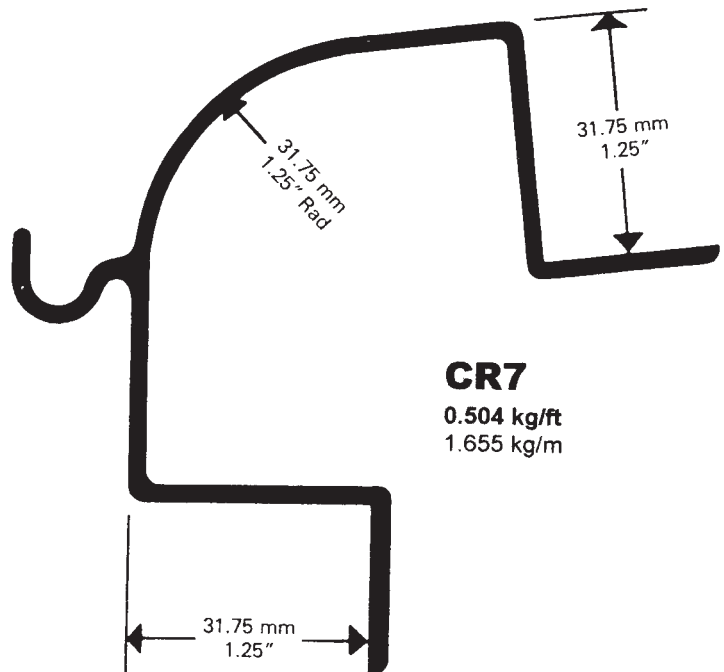

CR7
0.504 kg/ft
1.655 kg/m

Cant Rails

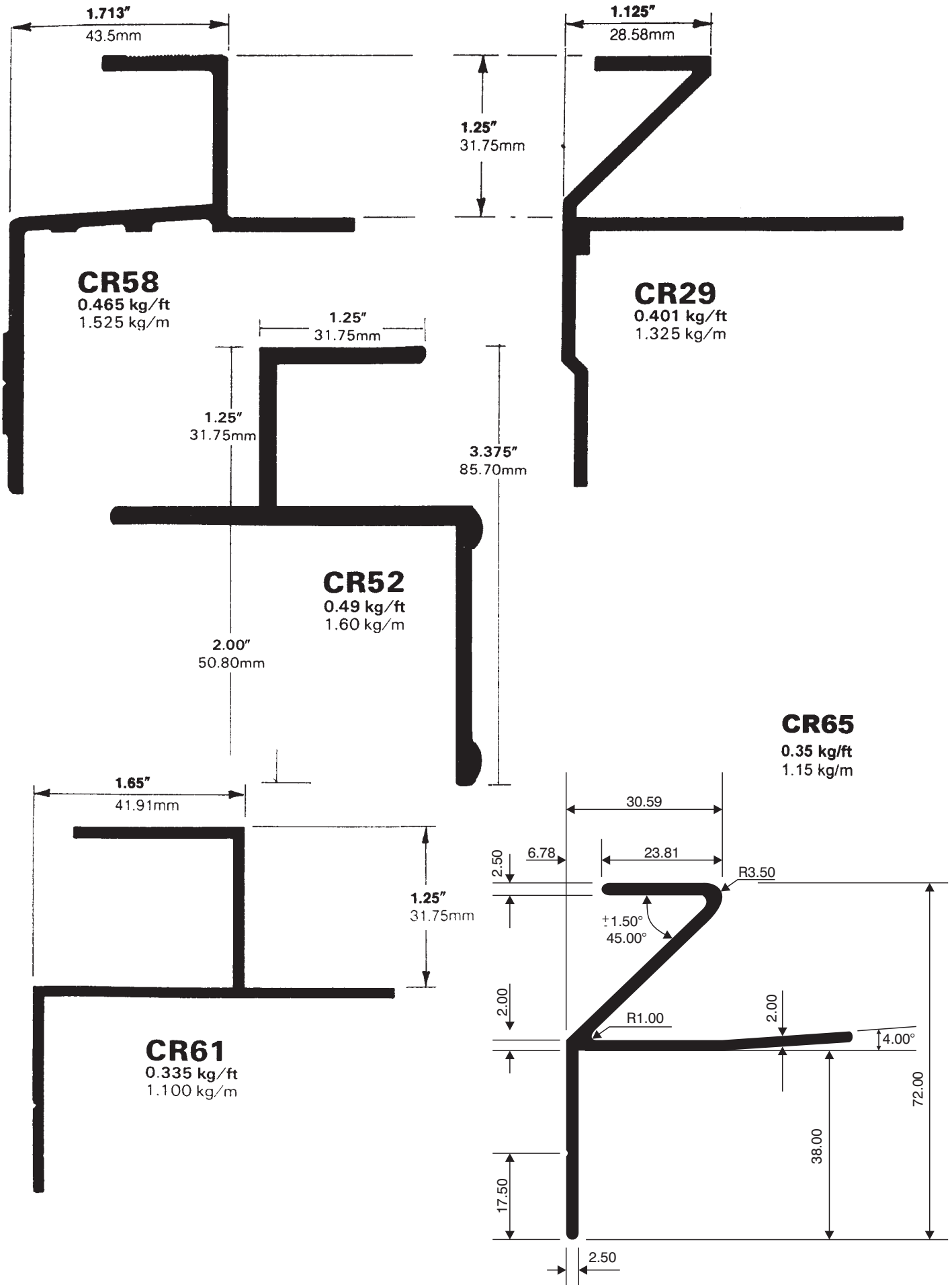

Cant Rails

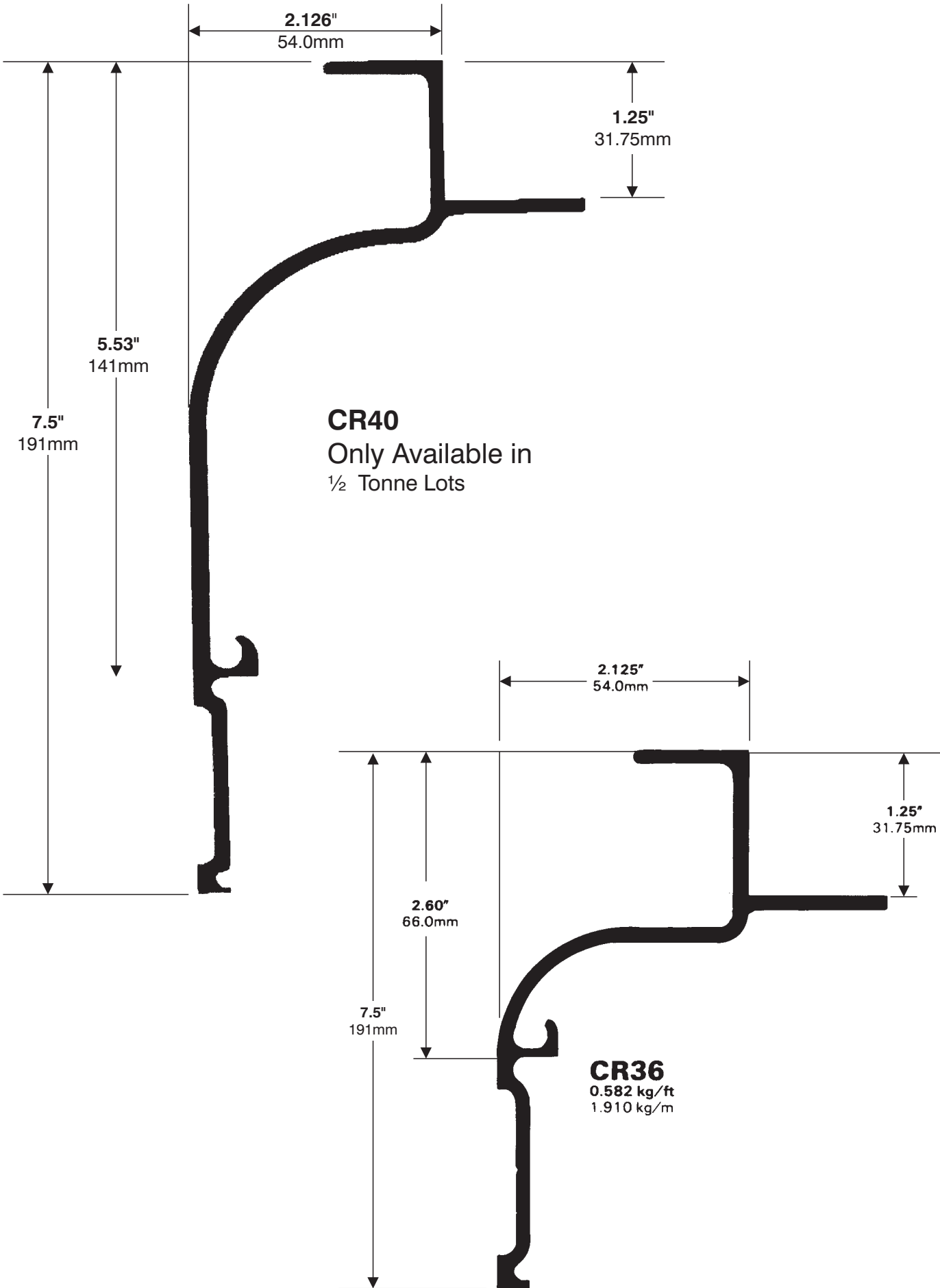

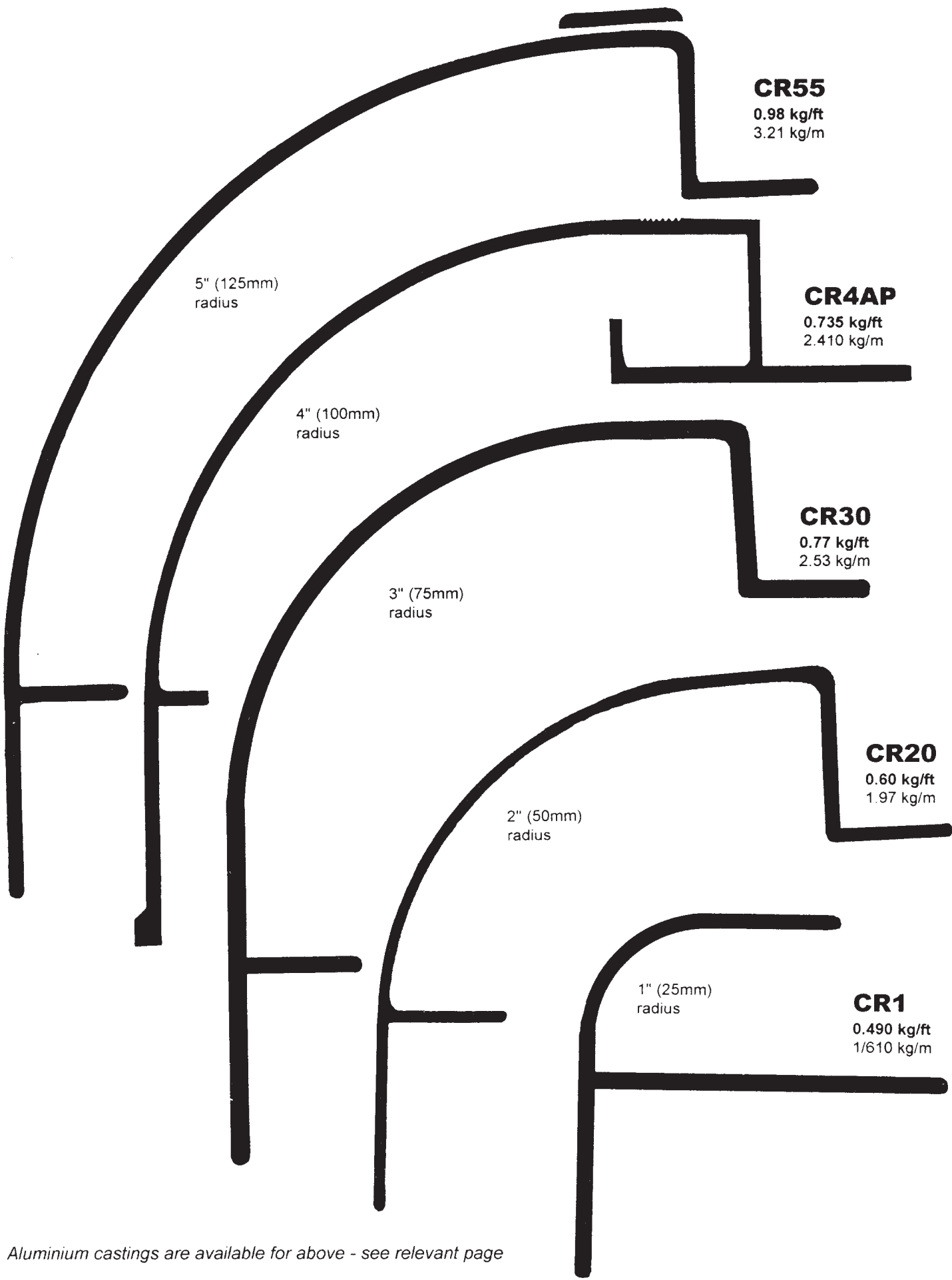

Aluminium castings are available for above - see relevant page



Cant Rails

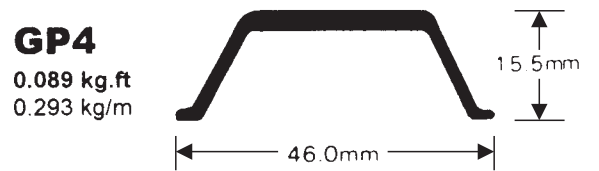
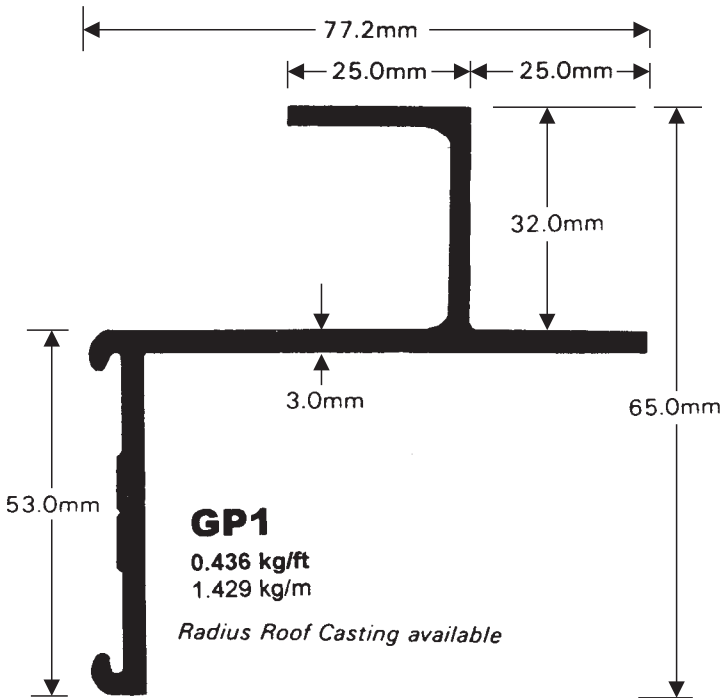
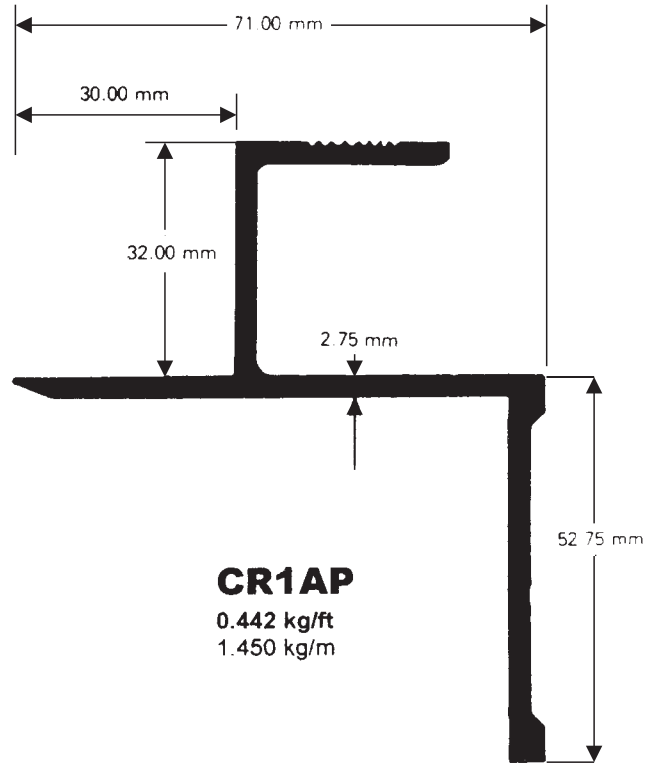
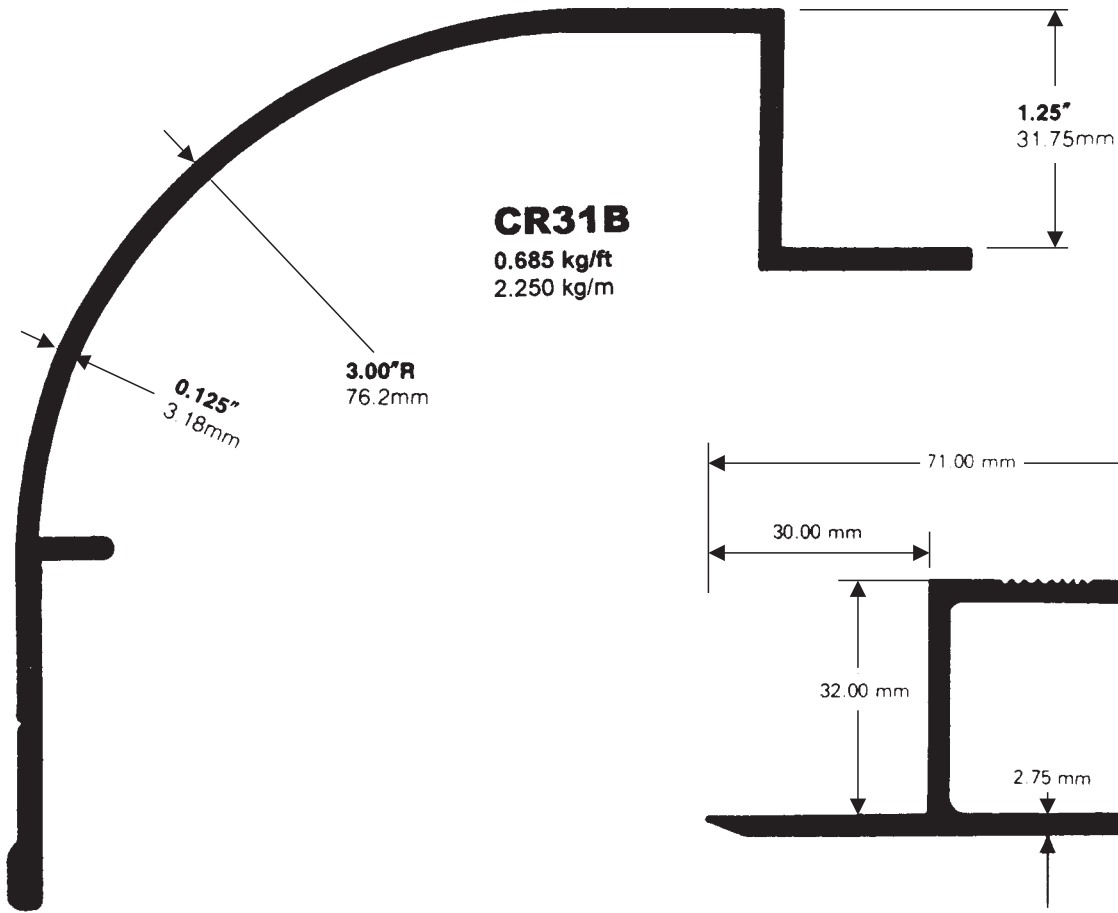



THE SERVICE METALS GROUP



★★★ **NEW PRODUCT** ★★★

INTRODUCING OUR NEW ALUMINIUM CAPTIVE GRP CANT RAIL

CR35 17mm Captive Cant Rail

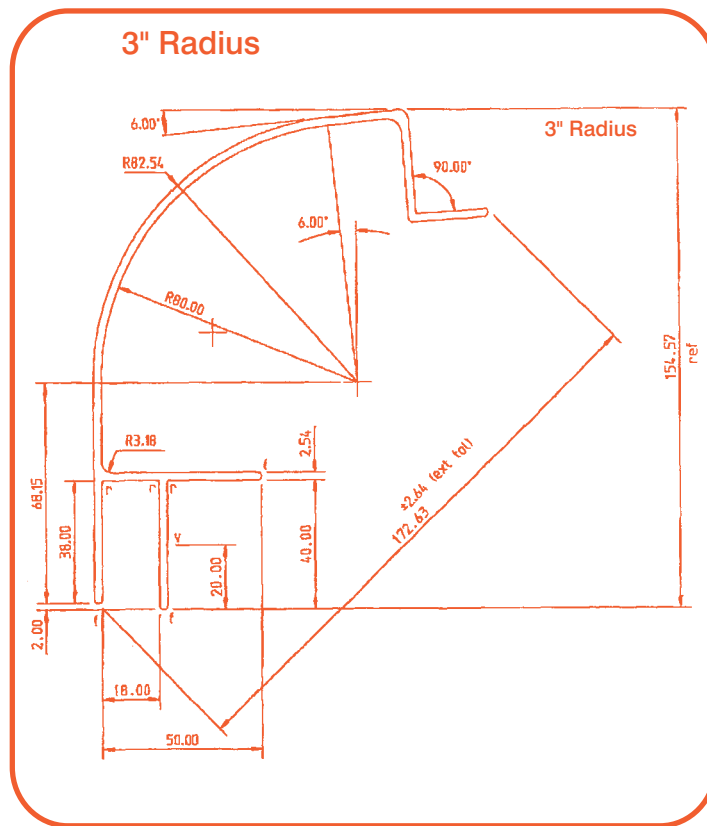

CR35 17mm Cant Rail

ADVANTAGES INCLUDE:-

★ **MORE COST EFFECTIVE / TIME SAVING** ★

★ **RIVET FREE EXTERIOR** ★

PLEASE CONTACT YOUR NEAREST SALES OFFICE FOR FAST EX STOCK DELIVERY



THE SERVICE METALS GROUP



★★★ **NEW PRODUCT** ★★★

INTRODUCING OUR NEW ALUMINIUM CAPTIVE GRP CANT RAIL

CR25 14mm Captive Cant Rail

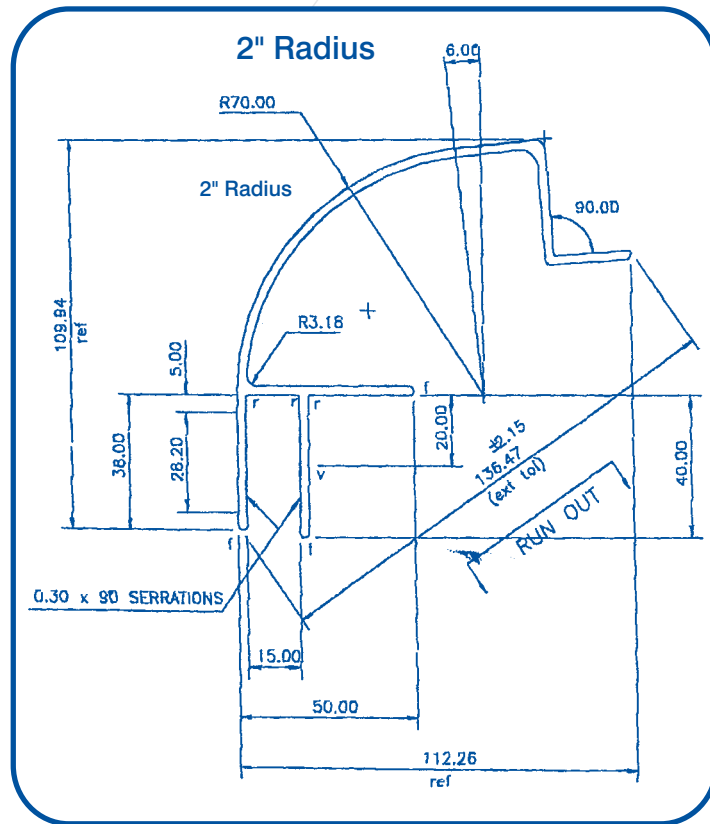

To be used in conjunction with TR5 and TR6 Castings

ADVANTAGES INCLUDE:-

- ★ MORE COST EFFECTIVE / TIME SAVING ★
- ★ RIVET FREE EXTERIOR ★

PLEASE CONTACT YOUR NEAREST SALES OFFICE FOR FAST EX STOCK DELIVERY