

Floor Planks

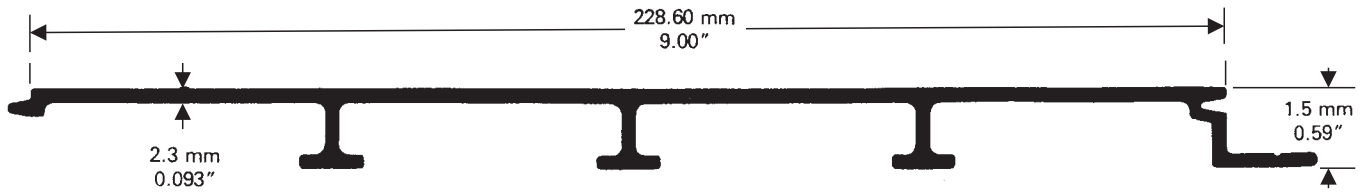

FP24

0.643 kg/ft
2.110 kg/m

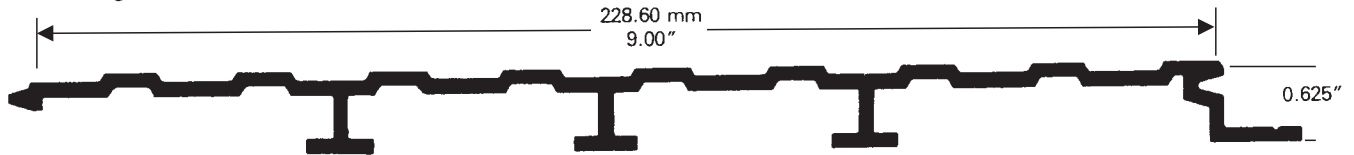

FP38

0.695 kg/ft
2.185 kg/m

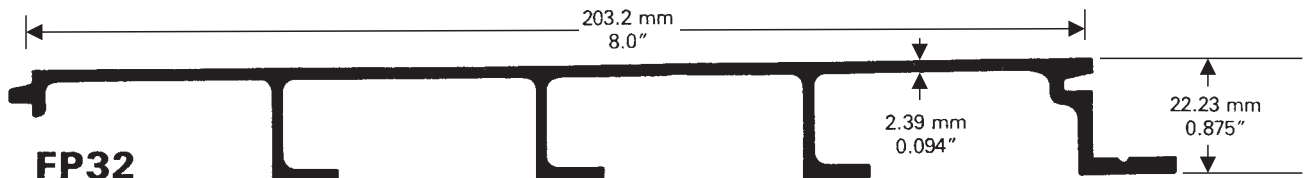

FP32

0.765 kg/ft
2.510 kg/m

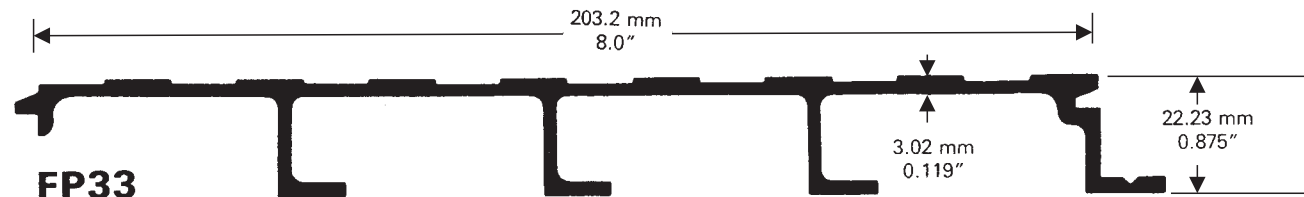

FP33

0.795 kg/ft
2.608 kg/m

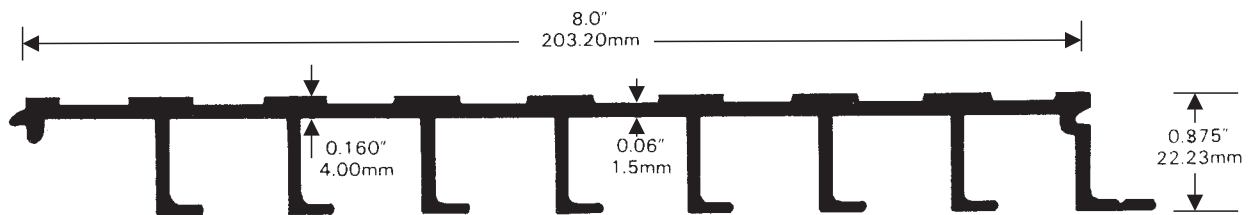

FP35

1.065 kg/ft
3.493 kg/m

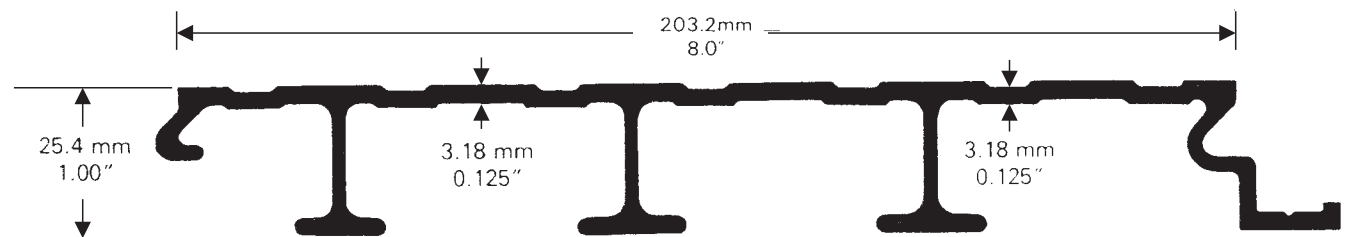

FP22

0.975 kg/ft
3.200 kg/m

Floor Planks

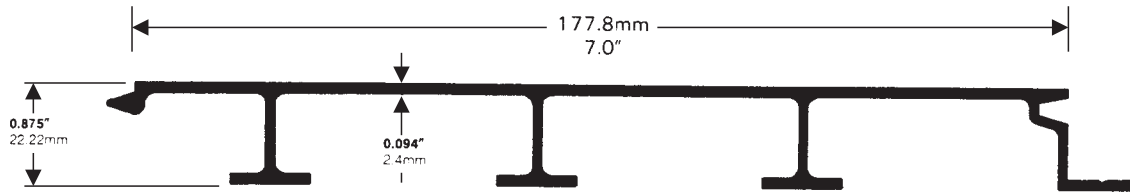

FP45

0.655 kg/ft
2.150 kg/m

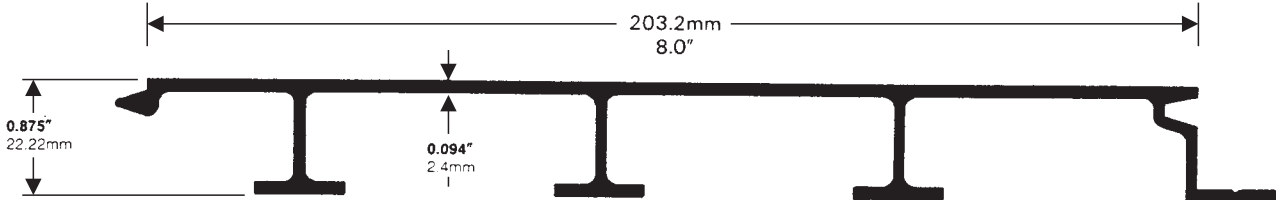

FP46

0.705 kg/ft
2.310 kg/m

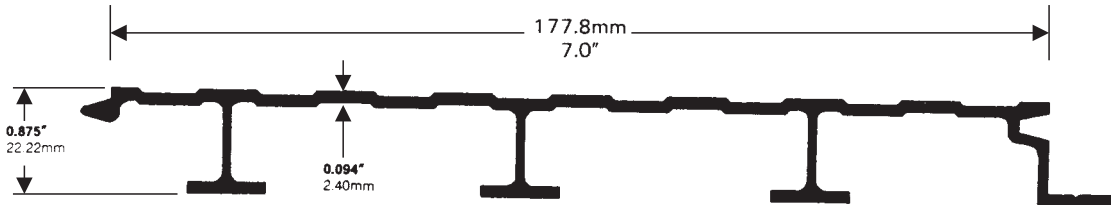

FP47

0.680 kg/ft
2.230 kg/m

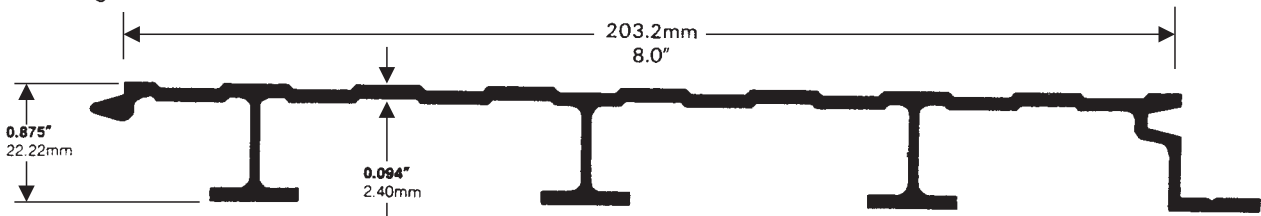

FP48

0.735 kg/ft
2.410 kg/m

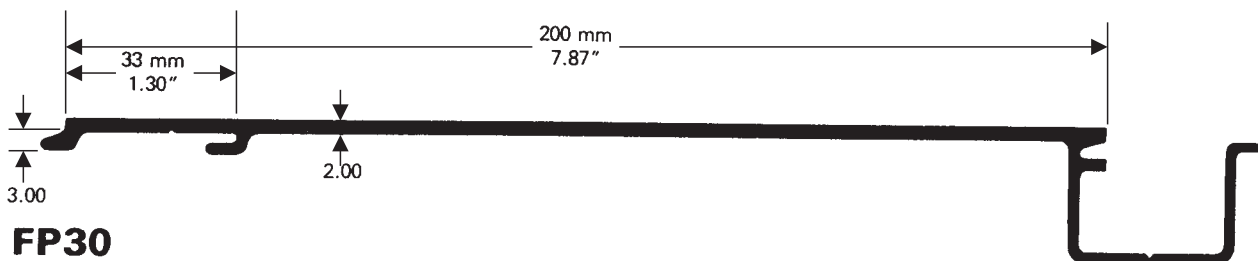

FP30

0.650 kg/ft
2.130 kg/m

Floor Planks

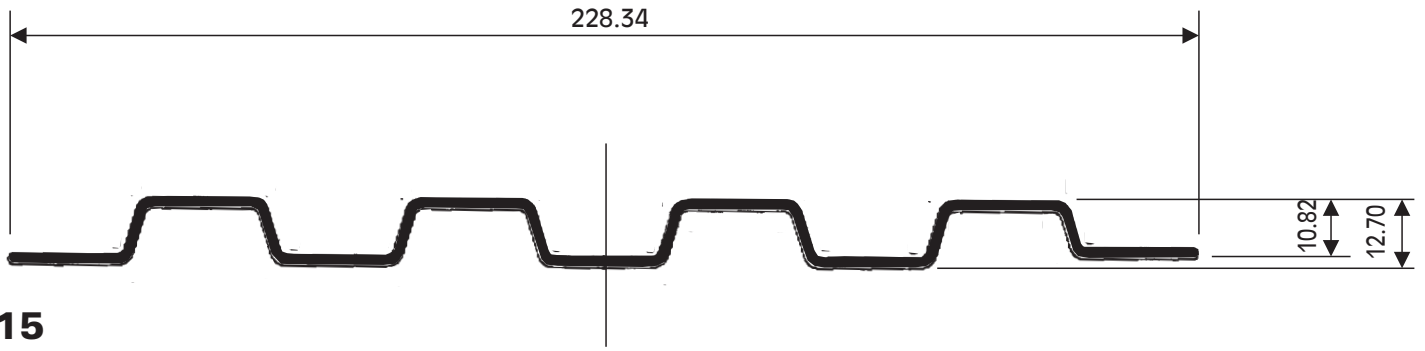

FP15
0.486 kg/ft
1.594 kg/m

WALL THICKNESS NOT SHOWN 1.98mm

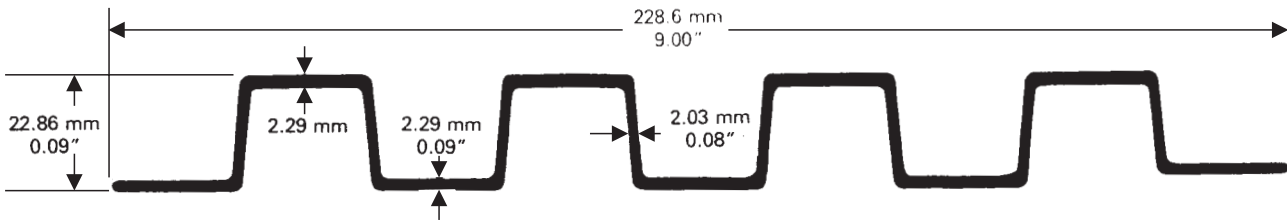

FP1
0.685 kg/ft
2.247 kg/m

Capping Sections

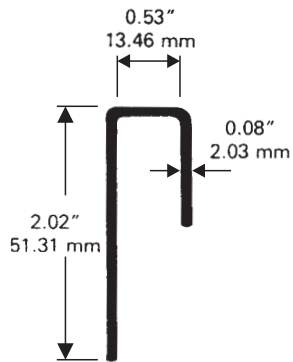

C68
0.148 kg/ft
0.490 kg/m

CAPPING SECTION FOR FP15

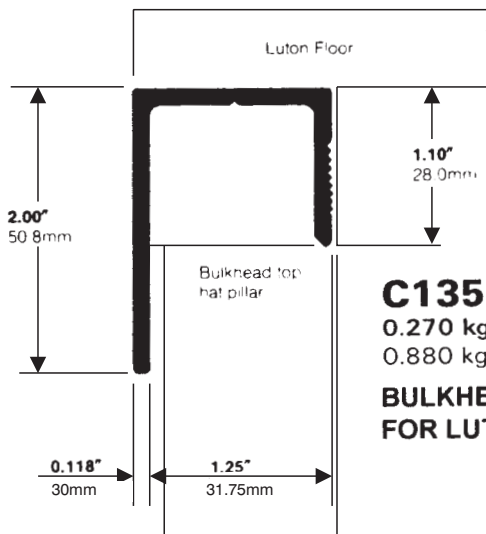

C135
0.270 kg/ft
0.880 kg/m

BULKHEAD CAPPING FOR LUTON BODY

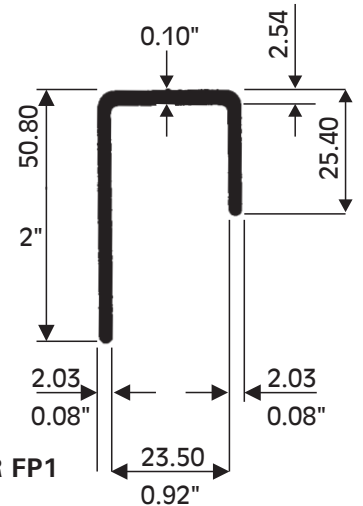

C66
0.175 kg/ft
0.580 kg/m

CAPPING SECTION FOR FP1

CS28
For use with FP15

CS28 CASTINGS AVAILABLE IN PAIRS
Five Pronged Castings also available

